



Customer information packet

EM4406T-4

150HP, 1785RPM, 3PH, 60HZ, 445T, A4488M, TEFC

Class - None

Division - Not Applicable

Specifications

Enclosure	TEFC
Frame	445T
Frame Material	Iron
Frequency	60.00 Hz
Haz Area Class and Group	None
Haz Area Division	Not Applicable
Motor Letter Type	Three Phase
Output @ Frequency	150.000 HP @ 60 HZ
Phase	3
Synchronous Speed @ Frequency	1800 RPM @ 60 HZ
Voltage @ Frequency	460.0 V @ 60 HZ
Agency Approvals	CCSAUSEEV
Ambient Temperature	40 °C
Auxiliary Box	NO AUXILLARY BOX
Base Indicator	Rigid
Bearing Grease Type	Polyrex EM (-20F +300F)
Current @ Voltage	169.000 A @ 460.0 V
Design Code	B
Drip Cover	No Drip Cover
Duty Rating	CONT
Efficiency @ 100% Load	95.8 %
Feedback Device	NO FEEDBACK
Heater Indicator	No Heater
High Voltage Full Load Amps	169.0 a
Insulation Class	F
Inverter Code	Inverter Ready
KVA Code	F
Lifting Lugs	Standard Lifting Lugs
Motor Lead Quantity/Wire Size	6 @ 2 AWG
Motor Standards	NEMA
Motor Type	A4488M
Mounting Arrangement	F1

Part detail

Revision	P
Type	AC
Mech. spec.	
Base	
Status	PRD/A
Elec. spec.	A44WG3783
Layout	617427-476
Eff. date	09-25-2025
CD Diagram	416820-008
Poles	04
Leads	6#2
Proprietary	False
Created date	08-10-2012

Number of Poles	4
Overall Length	44.75 IN
Power Factor	86
Product Family	Other
Pulley End Bearing Type	Ball
Pulley Face Code	Standard
Service Factor	1.15
Shaft Diameter	3.375 IN
Shaft Ground Indicator	No Shaft Grounding
Shaft Rotation	Reversible
Shaft Slinger Indicator	No Slinger
Speed	1785 rpm
Speed Code	Single Speed
Starting Method	Wye Start - Delta Run
Thermal Device - Bearing	None
Thermal Device - Winding	None

Nameplate

NP2349L

SPEC NO.	P44G3907	CAT.NO.	EM4406T-4	FRAME	445T				
HP	150	VOLTS	460	PHASE	3	DESIGN	B	TYPE	P
RPM	1785	AMPS	169	HZ	60	AMB	40	SF	1.15
DRIVE END BEARING	90BC03J30X	DUTY	CONT	INSUL.CLASS	F				
OPP D.E. BEARING	90BC03J30X	ENCL	TEFC	CODE	F				
SER.NO.		POWER FACTOR	86	NEMA-NOM-EFFICIENCY	95.8				
		MAX CORR KVAR	30.0	GUARANTEED EFFICIENCY	95.0				
		NEMA NOM/CSA QUOTED EFF							
		MOTOR WEIGHT							

Accessories

Part number	Description	Multiplier
089490106A	G28 C-FACE BRKT MACH-6318 089490105WCA	P1

REL. S.O.	FRAME	HP	TYPE	PHASE/HERTZ	RPM	VOLTS
	445VP	150	P	3/60	1785	460
AMPS	DUTY	AMB ^o C/ INSUL.	S.F.	NEMA DESIGN	CODE LETTER	ENCL.
169	CONT	40/F	1.15	B	F	TEFC
E/S	ROTOR	TEST S.O.	TEST DATE	STATOR RES. @25 ^o C (BETWEEN LINES)		
498865	418143053AE	---	---	.0298		

PERFORMANCE

LOAD	HP	AMPERES	RPM	% POWER FACTOR	% EFFICIENCY
NO LOAD	0	48.9	1800	4.26	0
1/4	37.6	69.1	1796	54.4	93.6
2/4	75.0	96.9	1792	75.7	95.7
3/4	112	131	1788	83.6	96.0
4/4	150	169	1784	86.8	95.8
5/4	188	210	1779	87.9	95.3

SPEED TORQUE

	RPM	TORQUE % FULL LOAD	TORQUE LB.-FT.	AMPERES
LOCKED ROTOR	0	130	572	1041
PULL UP	270	116	511	1020
BREAKDOWN	1729	280	1237	579
FULL LOAD	1784	100	442	169

AMPERES SHOWN FOR 460. VOLT CONNECTION. IF OTHER VOLTAGE CONNECTIONS ARE AVAILABLE, THE AMPERES WILL VARY INVERSELY WITH THE RATED VOLTAGE

REMARKS: TYPICAL DATA
NEMA NOMINAL EFFICIENCY = 95.8 PCT.

 A MEMBER OF THE ABB GROUP	DR. BY _____	CD _____	A-C MOTOR PERFORMANCE DATA A44WG3783-R001 ISSUE DATE 09/27/19
	CK. BY _____	CD _____	
	APP. BY F. KRALTI	DATE 1/18/11	

REL. S. O.		RPM	1785	S. F.	1.15	ROTOR	4181A3053AE
FRAME	445VP	VOLTS	460	NEMA DESIGN	B	TEST S. O.	TYPICAL DATA
HP	150	AMPS	169	CODE LETTER	F	TEST DATE	---
TYPE	P	DUTY	CONT	ENCLOSURE	TEFC	STATOR RES. @ 25 °C	.0298
PHASR./HERTZ	3/60	AMB °C/INSUL	40/F	E/S	498865	OHMS (BETWEEN LINES)	

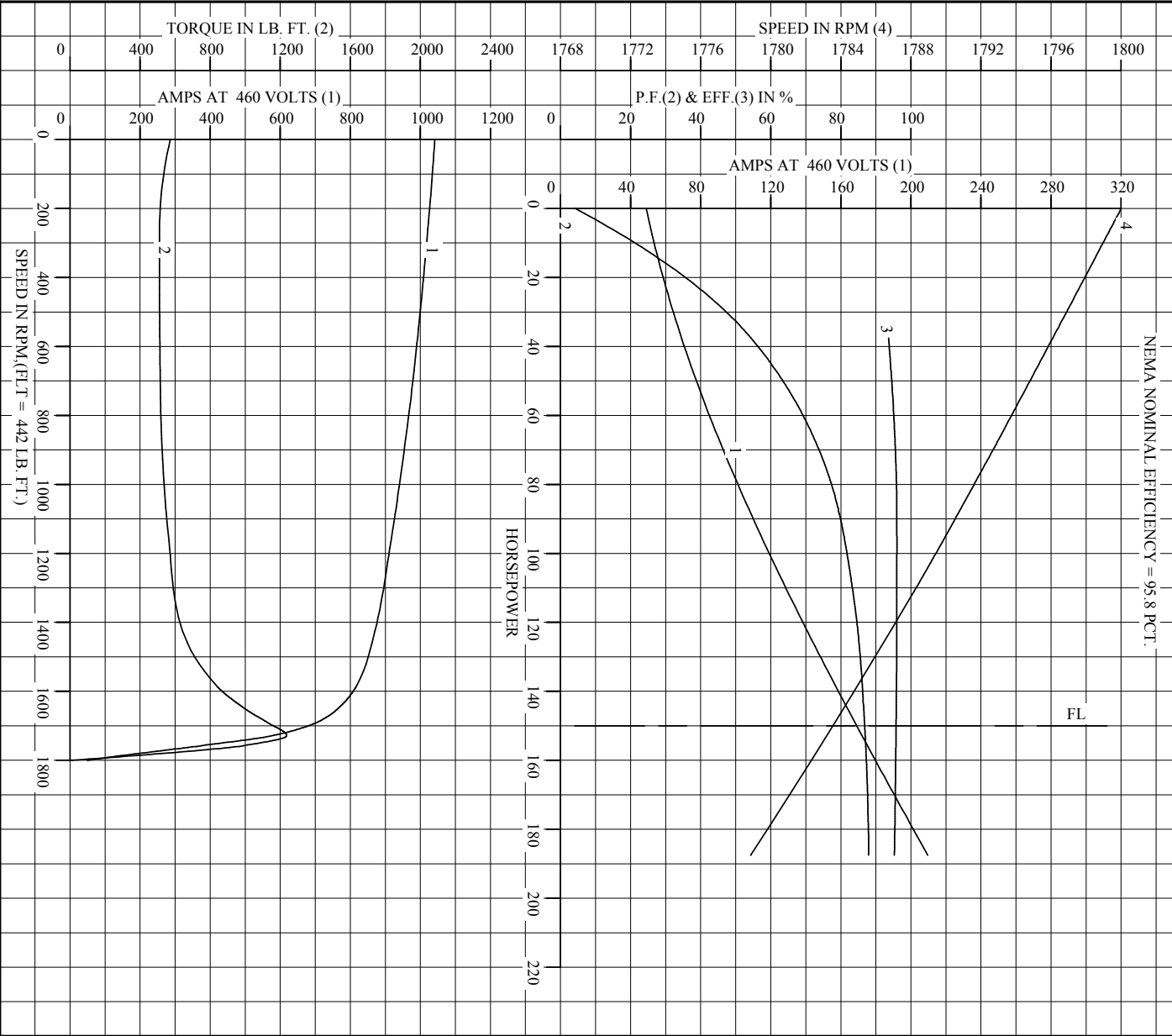

AMPERES SHOWN FOR 460 VOLT CONNECTION. IF OTHER VOLTAGE CONNECTIONS ARE AVAILABLE, THE AMPERES WILL VARY INVERSELY WITH THE RATED VOLTAGE.



DR. BY _____ CD
 CK. BY _____
 App. BY T. KELATI
 DATE 1/8/11

A-C MOTOR
PERFORMANCE
CURVES
 A44WG3783-R001
 ISSUE DATE 09/27/19

REL. S.O. _____ RPM **1785** S.F. **1.15** ROTOR **418143053AE**
 FRAME **445VP** VOLTS **460** NEMA DESIGN **B** TEST S.O. **TYPICAL DATA**
 HP **150** AMPS **169** CODE LETTER **F** TEST DATE **---**
 TYPE **P** DUTY **CONT** ENCLOSURE **TEFC** STATOR RES @ 25 °C **0.0298**
 PHASE/HERTZ **3/60** AMB °C/INSUL **40/F** E/S **498865** OMS (BETWEEN LINES)

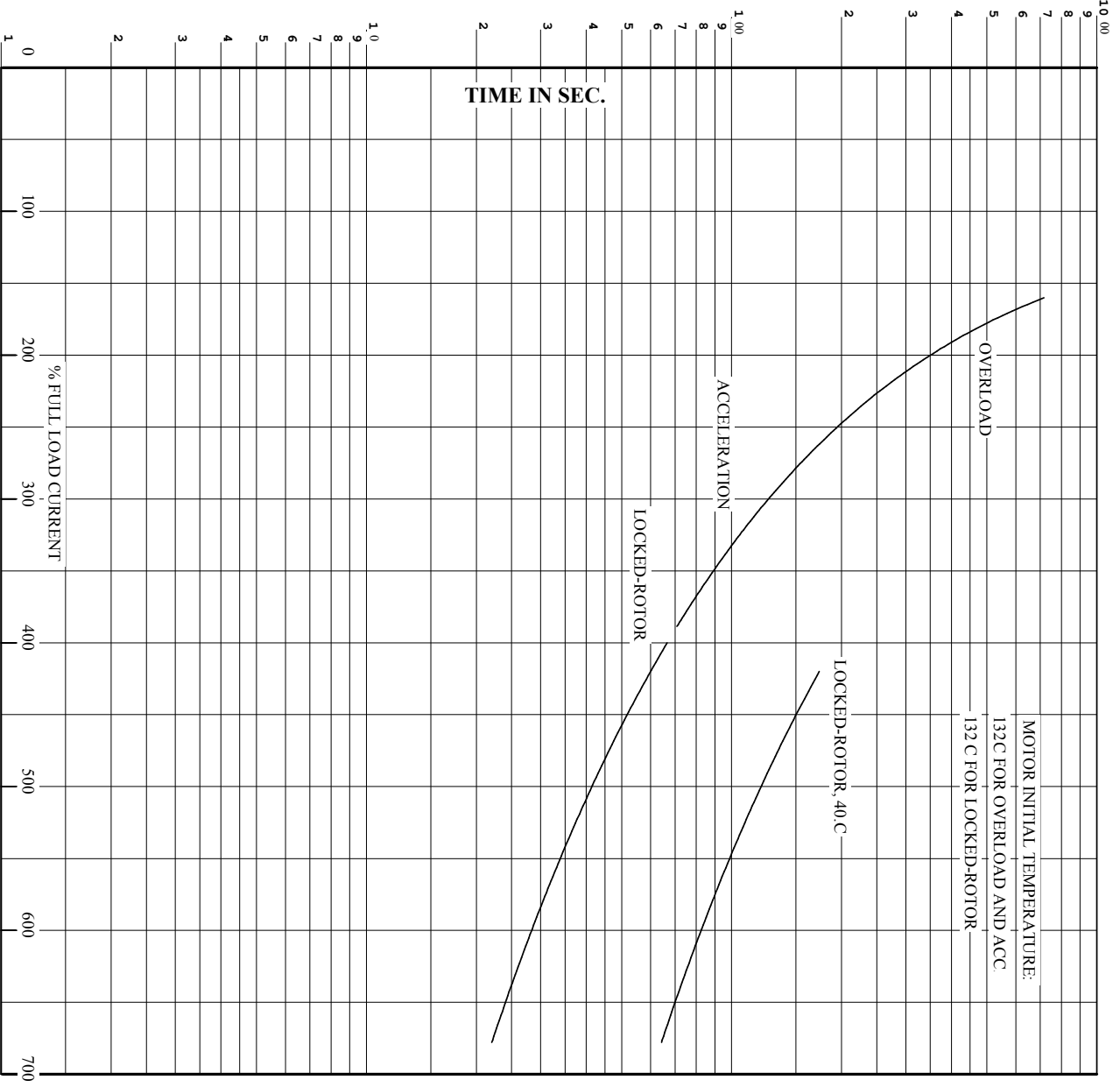

REMARKS: THERMAL LIMIT CURVE
 NEMA NOMINAL EFFICIENCY = 95.8 PCT.

AMPERES SHOWN FOR **460** VOLT CONNECTION, IF OTHER VOLTAGE CONNECTIONS ARE AVAILABLE, THE AMPERES WILL VARY INVERSELY WITH THE RATED VOLTAGE.

BALDOR A MEMBER OF THE ABB GROUP	DR. BY _____	CD _____	A-C MOTOR
	CK. BY _____	CD _____	
	APP. BY _____	T. KEHLATI _____	PERFORMANCE
	DATE _____	1/8/11 _____	CURVES
			A44WG3783-R001
			ISSUE DATE 09/27/19

617427-476

DUTY MASTER ALTERNATING CURRENT MOTORS
SQUIRREL-CAGE INDUCTION

ENCLOSURE: TOTALLY ENCLOSED

MOUNTING: FOOT, F-1 SIDE

FRAME G444T
INCLUDES G445T FRAME MOUNTING HOLES

STEEL MAIN CONDUIT BOX

COOLING: FAN COOLED

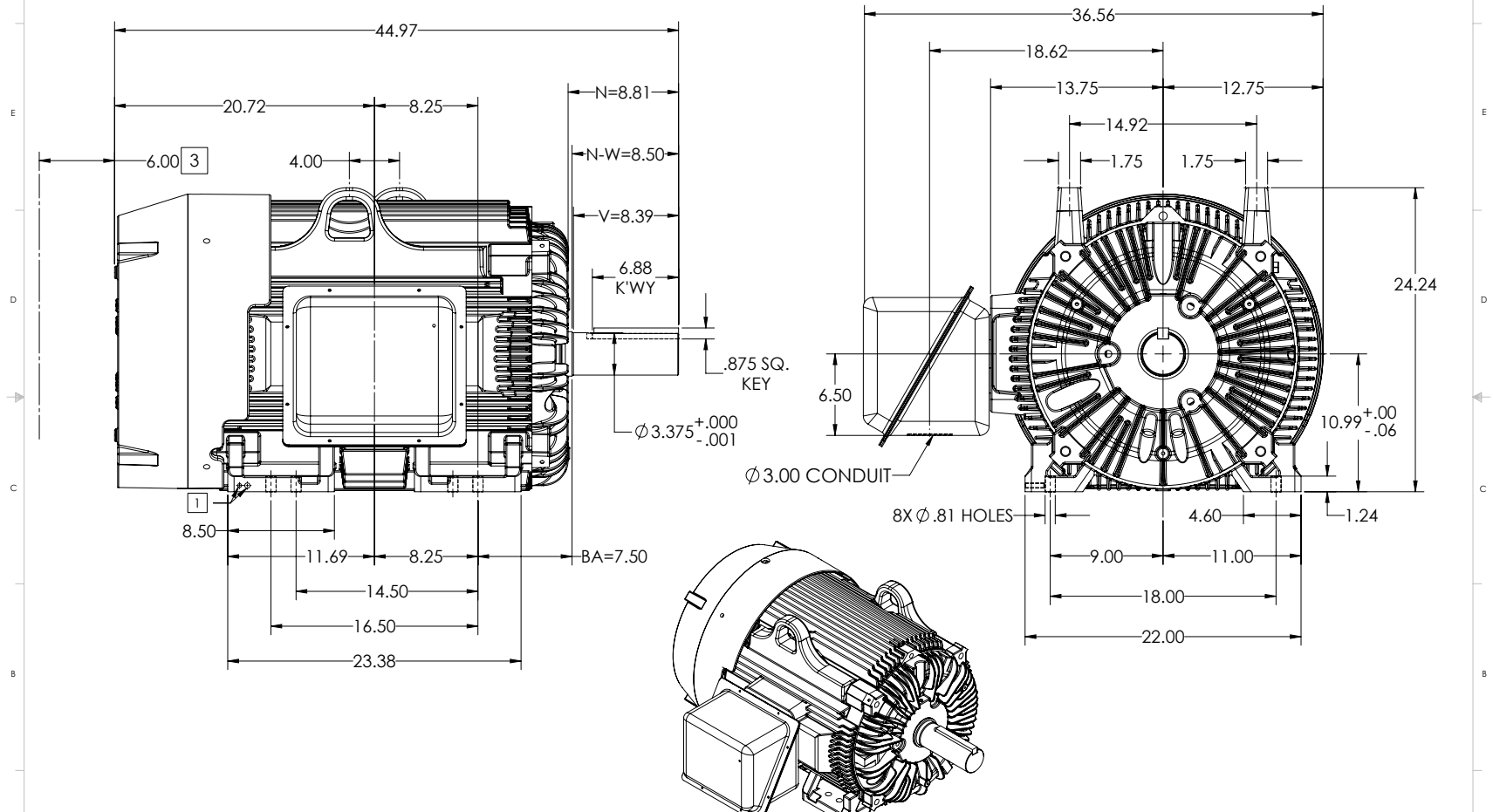

- 1 GROUND HOLES QTY 1 1/2-13 TAP; QTY 1 3/8-16 TAP
- 2 MOTOR WEIGHTS MAY VARY BY 15% DEPENDING ON RATING.
- 3 OBSTRUCTION MUST NOT ENCROACH ON AIR INLET

2 WEIGHT (LBS): 2130

DIMENSIONS ARE IN INCHES
CUSTOMER IS RESPONSIBLE FOR DETERMINING THAT MOTOR PERFORMANCE IS SUITABLE IN THE APPLICATION.

SHEET NUMBER
1 OF 1
9LF-272119

IF MOUNTING CLEARANCE DETAILS ARE REQUIRED, CONSULT FACTORY.
MAXIMUM PERMISSIBLE SHAFT RUNOUT WHEN MEASURED AT END OF
STANDARD SHAFT EXTENSION IS .003" T.I.R. TO 5 INCH DIA.

REV. DESC: NEW DRAWING	VERSION: 00	REVISED: 10/03/28 04/18/2015	TDR: 00000919063
MODEL NO. 617427-476	BY: RAGRA	Material:	REF:

BALDOR

G445T-444T TEFC FT - SD/CNTR - STEEL C/BOX

617427-476

416820-008

A-C MOTOR CONNECTION DIAGRAM

STANDARD 6 LEAD

Y START - DELTA RUN

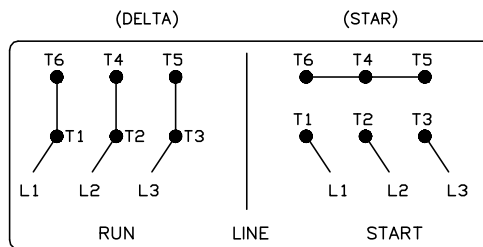
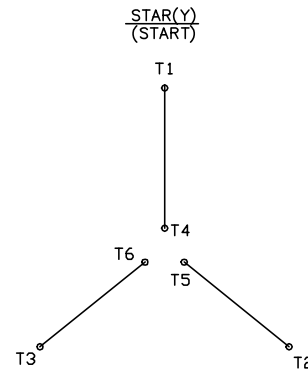
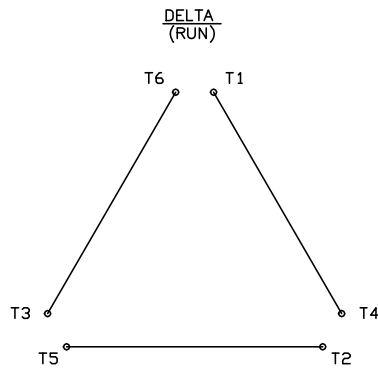

< N. P. 1767-DC >

REV. DESC: ADDED T4 TO Y CONNECT DIAGRAM		
REV. LTR: D	VERSION: 04	TDR: 00000847713
FILE: \RAG\00001\808	REVISED: 10:41:26 04/08/2014	BY: RAGJSS1
MTL: -	© □	

BALDOR

CONNECT DIAGRAM STD 6 LEAD Y START DELTA RUN

SH 1 of 1

416820-008